



DOBPLAST

PRODUCT CATALOGUE

AUTOMOTIVE

GENESIS

Dobplast was established in 2005. The name is the combination of the first letters of the founder's surname and the word plastic; which indicates that the main raw material used in the production of lamps and reflectors is plastic. The inspiration for the establishment of the company, came from the founder's family traditions dating back to the 1950s, related to the production of lights for passenger cars mainly of domestic use. Dobplast introduced its first patented product road cat eyes, in 2007. The time after Poland's accession to the European Union in 2004 was associated with the dynamic development of road infrastructure contributing to a significant increase in demand for road marking products. This enabled the rapid development of Dobplast and helped to provide the market with high-quality, innovative products to improve safety. Between 2013 and 2015, the first combination of tail lamps and reflectors used on trailers were introduced. Subsequently, the product range was expanded to include a whole range of products for road markings and various types of lights mounted on vehicles such as trailers, semi-trailers, bicycle racks, agricultural machinery and bicycles. Our goal for the coming years is to further develop our product range in such a direction as to meet the needs of our customers in a comprehensive manner, by providing innovative products of the highest quality based on research work carried out and the latest technologies available on the market

DESCRIPTION OF BUSINESS

We specialize in manufacturing products for the automotive industry. In our factory, all products are manufactured based on modern technologies, using high-end raw materials. We have a quality management system in place, and our company introduces numerous innovations as a result of research and development work carried out. We sell our products to nearly twenty-five countries located around the globe. We are able to implement ambitious projects according to the highest requirements of our customers.

SERVICES

Additionally, we offer the following range of services:

- ✓ Products design
- ✓ Production of plastic products by injection moulding
- ✓ Production of metal parts by punching
- ✓ Assembling of cables and wire harnesses
- ✓ Vacuum coating
- ✓ The assembling of plastic parts
- ✓ Ultrasonic welding
- ✓ Prototyping
- ✓ Production of injection moulds
- ✓ CNC machining

EXPORT MAP

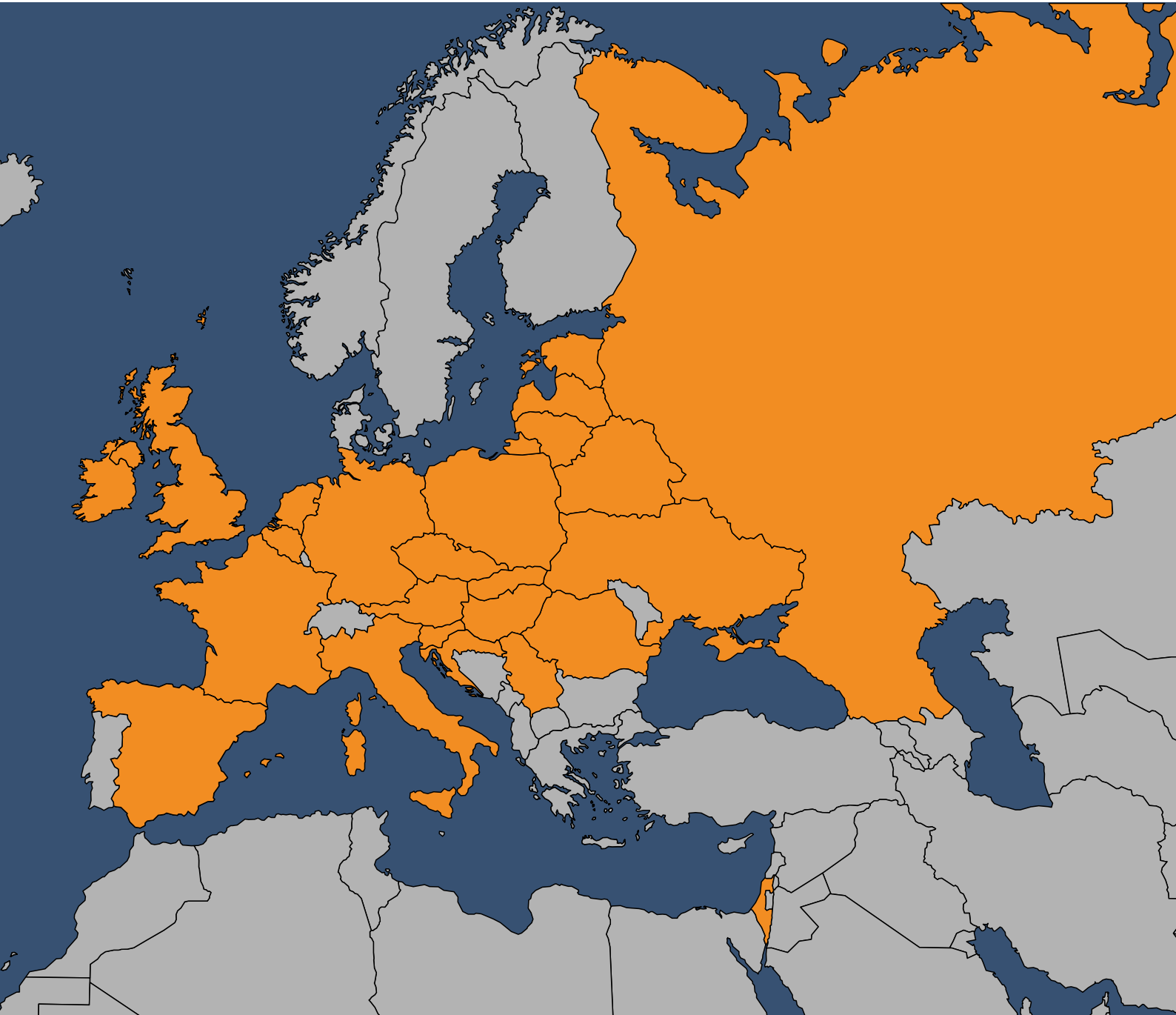

 Countries to which we export

REAR LAMPS



Rear multifunctional lamp DPT30 LED



INFO:

- modern design
- supply voltage 12/24V
- replaceable lens and LED modules
- airtight waterproof IP68 LED modules
- european homologation E20
- electromagnetic compatibility (EMC)
- designed for car trailers, towbar bike racks, agriculture vehicles etc.

FUNCTIONS:

- stop light
- position light
- indicator
- number plate light
- reversing or fog light
- reflective device

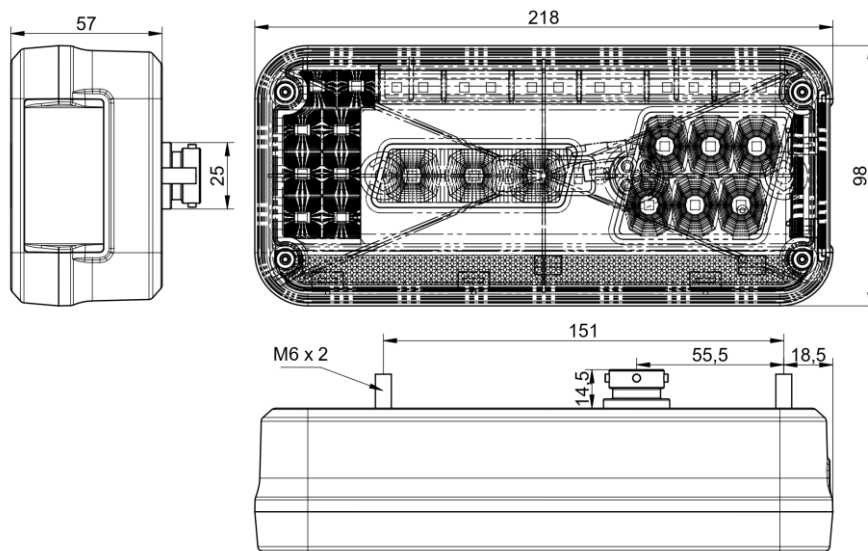



Rear multifunctional lamp

DPT30 LED



 IP68



Product code EAN code	Photo	Description
0030-1001 5905591400039		left lamp, position light, stop light, indicator, fog light, registration plate light, reflector, bayonet socket
0030-1002 5905591400046		right lamp, position light, stop light, indicator, reversing light, registration plate light, reflector, bayonet socket
0030-1003 5905591400053		right lamp, position light, stop light, indicator, registration plate light, reflector, bayonet socket

Rear multifunctional lamp DPT35 LED



INFO:

- supply voltage 12/24V
- replaceable lens and LED modules
- airtight waterproof IP68 LED modules
- european homologation E20
- electromagnetic compatibility (EMC)

FUNCTIONS:

- stop light
- position light
- indicator
- number plate light
- reversing or fog light
- triangular reflective device

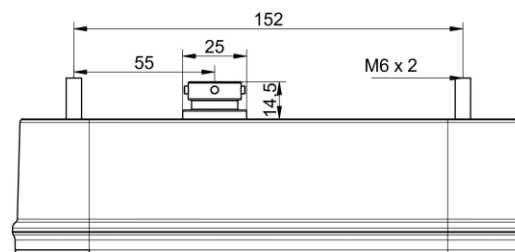
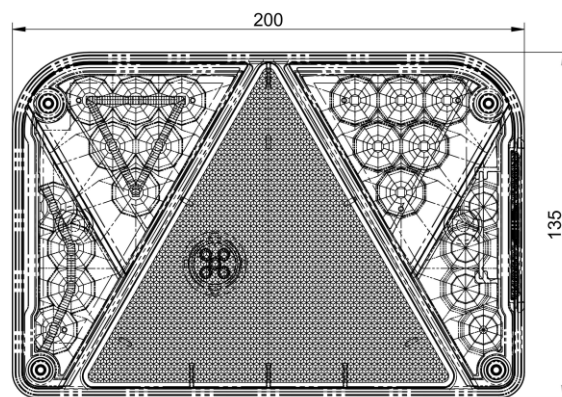
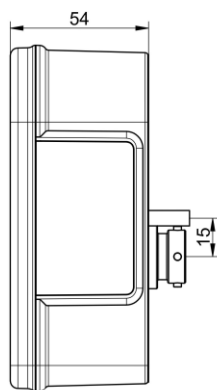



Rear multifunctional lamp

DPT35 LED



 IP68



Product code EAN code	Photo	Description
0035-1001 5905591400008		left lamp, position light, stop light, indicator, fog light, registration plate light, reflective triangle, bayonet socket
0035-1002 5905591400015		right lamp, position light, stop light, indicator, reversing light, registration plate light, reflective triangle, bayonet socket
0035-1003 5905591400022		right lamp, position light, stop light, indicator, registration plate light, reflective triangle, bayonet socket

Rear multifunctional lamp

DPT30



INFO:

- modern design
- supply voltage 12/24V
- european homologation E20
- designed for car trailers, towbar bike racks, agriculture vehicles etc.

FUNCTIONS:

- stop light
- position light
- indicator
- number plate light
- reversing or fog light
- reflective device

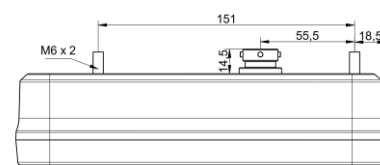
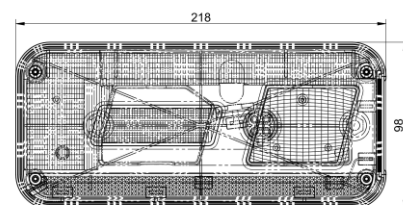
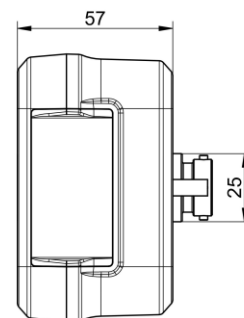

Product code EAN code	Photo	Description
0030-0001 5905591400411		left lamp, position light, stop light, indicator, fog light, registration plate light, reflector, bayonet socket * bulbs inside
0030-0002 5905591400428		right lamp, position light, stop light, indicator, reversing light, registration plate light, reflector, bayonet socket * bulbs inside
0030-0003 5905591400435		right lamp, position light, stop light, indicator, registration plate light, reflector, bayonet socket * bulbs inside
0030-0004 5905591400459		left lamp, position light, stop light, indicator, fog light, registration plate light, reflector, grommet
0030-0005 5905591400442		right lamp, position light, stop light, indicator, reversing light, registration plate light, reflector, grommet

Multifunctional lamp with reflective triangle

DPT35







INFO:

- compact multifunctional lamp with reflective triangle
- supply voltage 12/24V
- european homologation E20

FUNCTIONS:

- stop light
- position light
- indicator
- number plate light
- reversing or fog light
- triangular reflective device

Product code EAN code	Photo	Description
0035-0001 5905591400466		left lamp, position light, stop light, indicator, fog light, registration plate light, reflective triangle, bayonet socket 💡 - bulbs inside
0035-0002 5905591400473		right lamp, position light, stop light, indicator, reversing light, registration plate light, reflective triangle, bayonet socket 💡 - bulbs inside
0035-0003 5905591400480		right lamp, position light, stop light, indicator, registration plate light, reflective triangle, bayonet socket 💡 - bulbs inside
0035-0004 5905591400503		left lamp, position light, stop light, indicator, fog light, registration plate light, reflective triangle, grommet
0035-0005 5905591400497		right lamp, position light, stop light, indicator, reversing light, registration plate light, reflective triangle, grommet

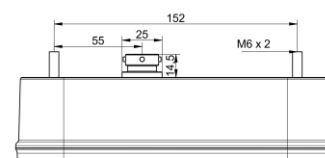
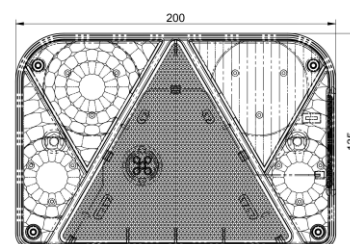
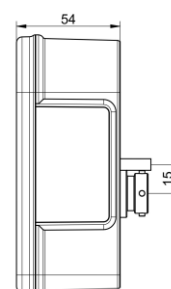

Rear lamp **DPT25**







INFO:

- rear lamp designed for trailers and bicycle carriers
- 4 functions
- homologation E20

FUNCTIONS:

- stop light
- position light
- indicator
- number plate light

Product code EAN code	Photo	Description
0025-0001 5905591400350		left / right lamp, position light, stop light, indicator, registration plate light, bayonet
0025-0101 5905591400367		left / right lamp, position light, stop light, indicator light, bayonet
0025-0004 5905591400374		left / right lamp, position light, stop light, indicator, registration plate light, grommet
0025-0104 5905591400381		left / right lamp, position light, stop light, indicator, grommet

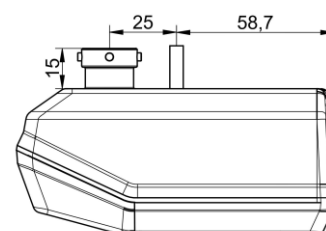
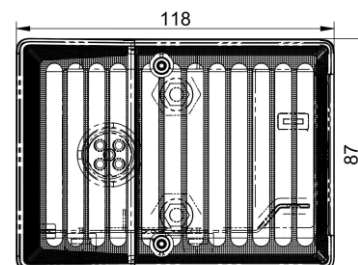
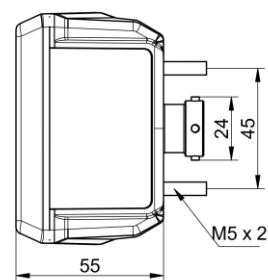

Rear lamp **DPT10**





INFO:

- rear lamp designed for trailers or bicycle carriers
- 4 functions
- homologation E20

FUNCTIONS:

- stop light
- position light
- indicator
- number plate light

Product code EAN code	Photo	Description
0010-0004 5905591400398		left / right lamp, position light, stop light, indicator, registration plate light, grommet
0010-0104 5905591400404		left / right lamp, position light, stop light, indicator, grommet

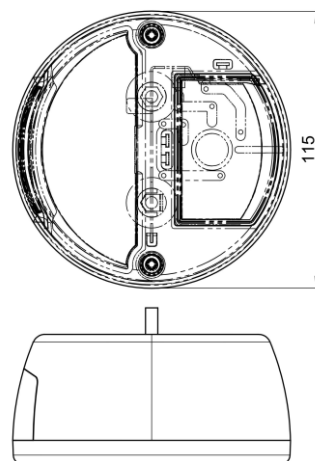
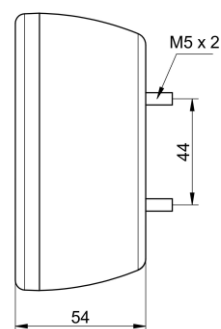

CLEARANCE LAMPS



Clearance lamp

DPT105 LED

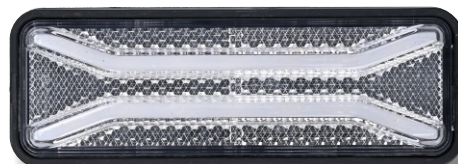

INFO:

- designed to indicate the size of trailers (front, side, rear)
- supply voltage 12/24V
- waterproof IP68
- with reflector
- compatible with various types of brackets (also fluorescent)
- low power consumption
- electromagnetic compatibility (EMC)
- homologation E20

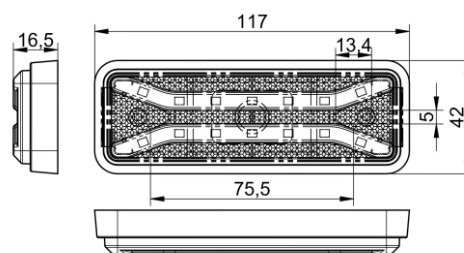
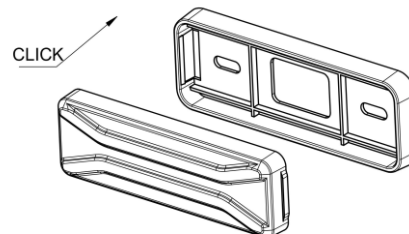

Product code EAN code	Photo	Description
0105-1051 5905591400831		clearance lamp LED, white, cable 0,5m
0105-1052 5905591400824		side-marker lamp LED, yellow, cable 0,5m
0105-1053 5905591400848		clearance lamp LED, red, cable 0,5m

Clearance lamp with C-bracket

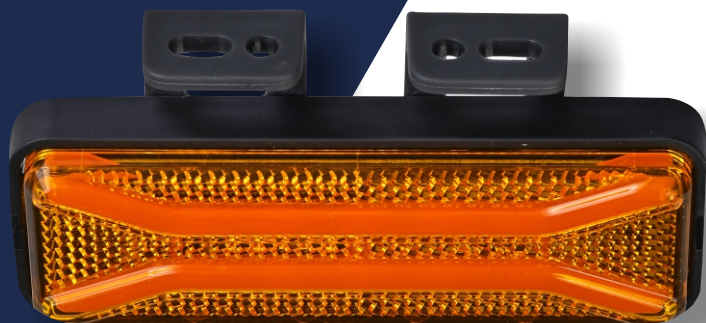

DPT105 LED

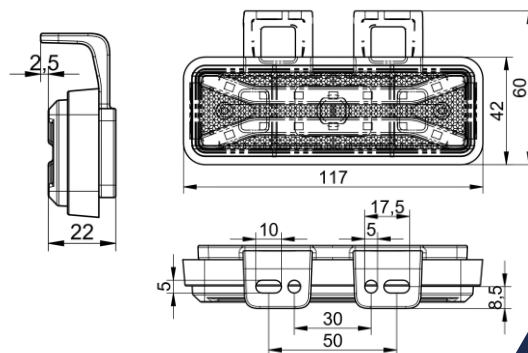

INFO:

- designed to indicate the size of trailers (front, side, rear)
- supply voltage 12/24V
- waterproof IP68
- with reflector
- compatible with various types of brackets (also fluorescent)
- low power consumption
- electromagnetic compatibility (EMC)
- homologation E20



Product code EAN code	Photo	Description
0105-1051-03C 5905591400855		clearance lamp LED, white, C-bracket, cable 0,5m
0105-1052-03C 5905591400862		side-marker lamp LED, yellow, C-bracket, cable 0,5m
0105-1053-03C 5905591400879		clearance lamp LED, red, C-bracket, cable 0,5m



Photoluminescent
bracket

Clearance lamp with Z-bracket

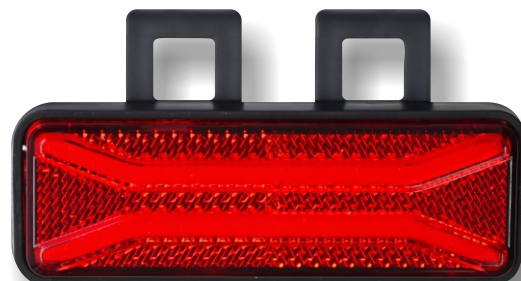
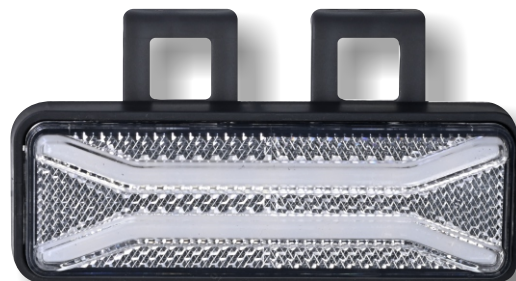
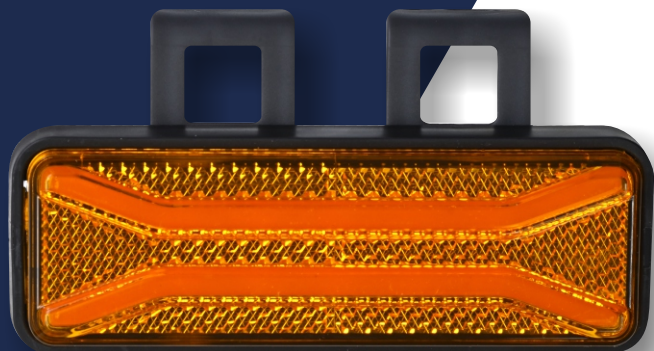

DPT105 LED

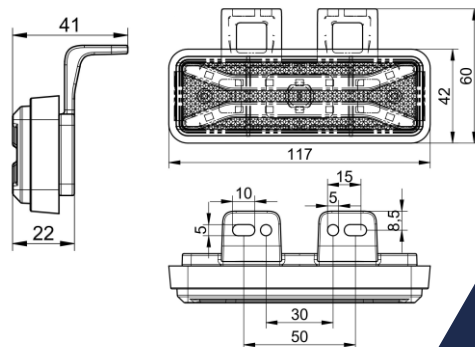

INFO:

- designed to indicate the size of trailers (front, side, rear)
- supply voltage 12/24V
- waterproof IP68
- with reflector
- compatible with various types of brackets (also fluorescent)
- low power consumption
- electromagnetic compatibility (EMC)
- homologation E20



Product code EAN code	Photo	Description
0105-1051-03Z 5905591400893		clearance lamp LED, white, Z-bracket, cable 0,5m
0105-1052-03Z 5905591400909		side-marker lamp LED, yellow, Z-bracket, cable 0,5m
0105-1053-03Z 5905591400886		clearance lamp LED, red, Z-bracket, cable 0,5m



Photoluminescent
bracket

Clearance lamp with long bracket



DPT105 LED

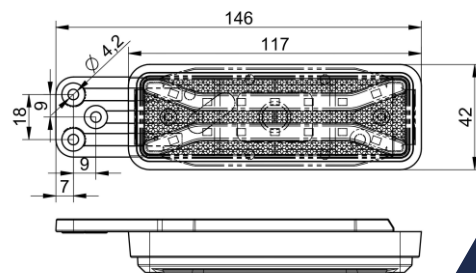
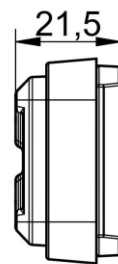

INFO:

- designed to indicate the size of trailers (front, side, rear)
- supply voltage 12/24V
- waterproof IP68
- with reflector
- compatible with various types of brackets (also fluorescent)
- low power consumption
- electromagnetic compatibility (EMC)
- homologation E20



Product code EAN code	Photo	Description
0105-1051-02 5905591400923		clearance lamp LED, white, long bracket, cable 0,5m
0105-1052-02 5905591400916		side-marker lamp LED, yellow, long bracket, cable 0,5m
0105-1053-02 5905591400930		clearance lamp LED, red, long bracket, cable 0,5m



Photoluminescent
bracket

Clearance lamp



DPT100 LED

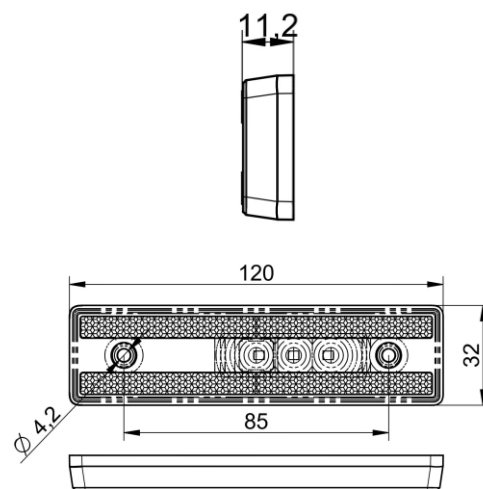

INFO:

- designed to indicate the size of trailers (front, side, rear)
- supply voltage 12/24V
- waterproof IP68
- with reflector
- compatible with various types of brackets (also fluorescent)
- low power consumption
- electromagnetic compatibility (EMC)
- homologation E20



Product code EAN code	Photo	Description
0100-1051 5905591400794		clearance lamp LED, white, cable 0,5m
0100-1052 5905591400800		side-marker lamp LED, yellow, cable 0,5m
0100-1053 5905591400817		clearance lamp LED, red, cable 0,5m

Clearance lamp with C-bracket

DPT100 LED

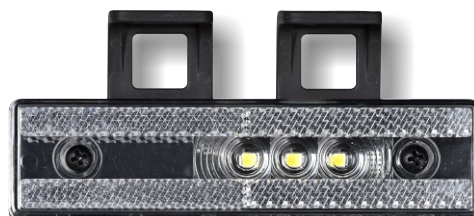
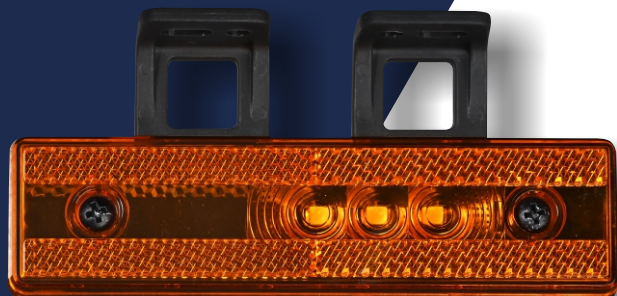

INFO:

- designed to indicate the size of trailers (front, side, rear)
- supply voltage 12/24V
- waterproof IP68
- with reflector
- compatible with various types of brackets (also fluorescent)
- low power consumption
- electromagnetic compatibility (EMC)
- homologation E20

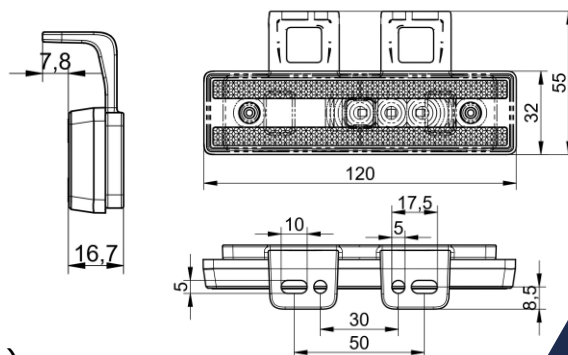

Product code EAN code	Photo	Description
0100-1051-03C 5905591400985		clearance lamp LED, white, C-bracket, cable 0,5m
0100-1052-03C 5905591400978		side-marker lamp LED, yellow, C-bracket, cable 0,5m
0100-1053-03C 5905591400992		clearance lamp LED, red, C-bracket, cable 0,5m



Photoluminescent
bracket

Clearance lamp with Z-bracket

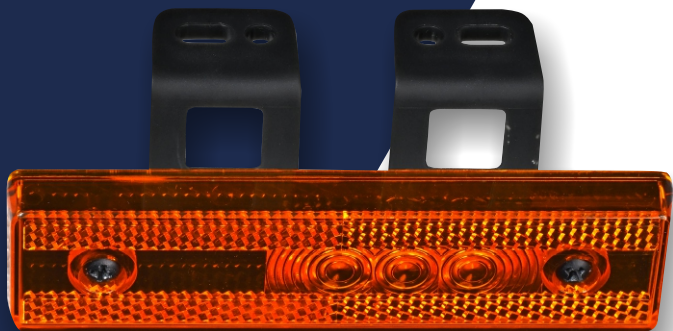

DPT100 LED

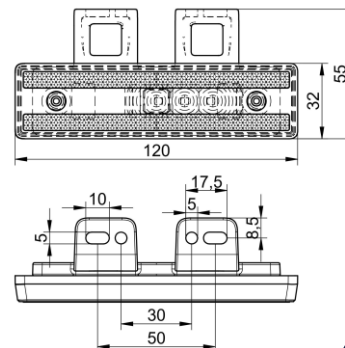
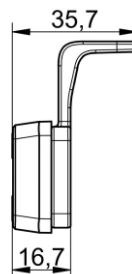

INFO:

- designed to indicate the size of trailers (front, side, rear)
- supply voltage 12/24V
- waterproof IP68
- with reflector
- compatible with various types of brackets (also fluorescent)
- low power consumption
- electromagnetic compatibility (EMC)
- homologation E20



Product code EAN code	Photo	Description
0100-1051-03Z 5905591400947		clearance lamp LED, white, Z-bracket, cable 0,5m
0100-1052-03Z 5905591400961		side-marker lamp LED, yellow, Z-bracket, cable 0,5m
0100-1053-03Z 5905591400954		clearance lamp LED, red, Z-bracket, cable 0,5m



Photoluminescent
bracket

Clearance lamp **DPT15**

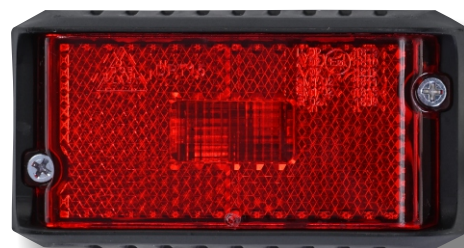

INFO:

- designed to indicate the size of trailers (front, side, rear)
- can be installed with the bracket or directly on board the trailer
- compatible with various types of brackets
- light source – bulb
- homologation E20

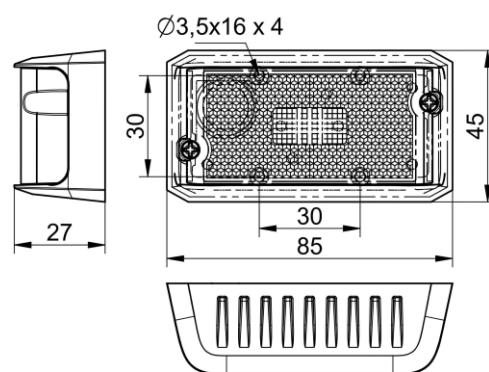

Product code EAN code	Photo	Description
0015-0051 5905591400671		clearance lamp, white, cable 0,5m
0015-0052 5905591400688		side-marker lamp, yellow, cable 0,5m
0015-0053 5905591400695		clearance lamp, red, cable 0,5m

Clearance lamp with long bracket

DPT15



INFO:

- designed to indicate the size of trailers (front, side, rear)
- can be installed with the bracket or directly on board the trailer
- compatible with various types of brackets
- light source – bulb
- homologation E20



Product code EAN code	Photo	Description
0015-0051-02 5905591400619		clearance lamp, white, long bracket, cable 0,5m
0015-0052-02 5905591400640		side-marker lamp, yellow, long bracket, cable 0,5m
0015-0053-02 5905591400633		clearance lamp, red, long bracket, cable 0,5m

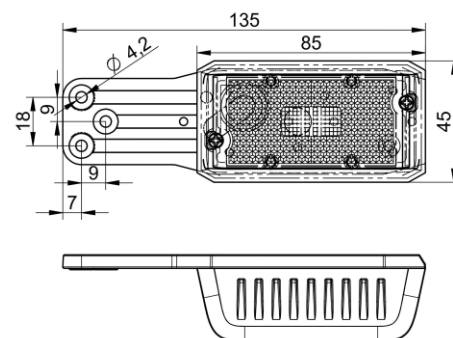

Clearance lamp with bracket

DPT15



INFO:

- designed to indicate the size
- can be installed with the bracket or directly on board the trailer
- light source – bulb
- homologation E20

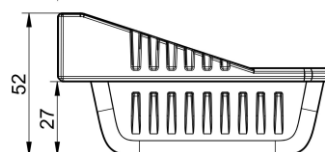
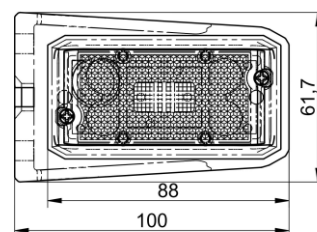
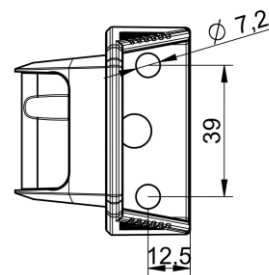

Product code EAN code	Photo	Description
0015-0051-01 5905591400558		clearance lamp, white, bracket, cable 0,5m
0015-0052-01 5905591400596		side-marker lamp, yellow, bracket, cable 0,5m
0015-0053-01 5905591400602		clearance lamp, red, bracket, cable 0,5m

Clearance lamp

DPT15 LED

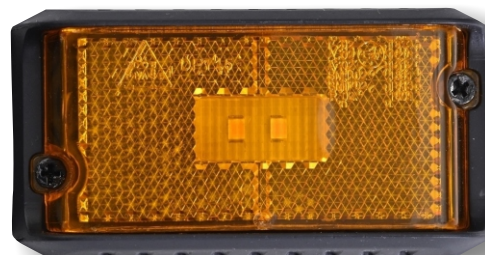
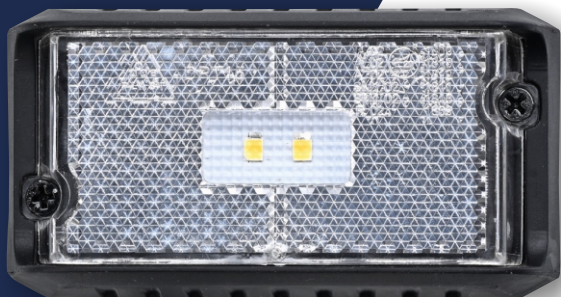

INFO:

- designed to indicate the size of trailers (front, side, rear)
- can be installed with the bracket or directly on board the trailer
- compatible with various types of brackets
- electromagnetic compatibility (EMC)
- homologation E20
- light source – LED

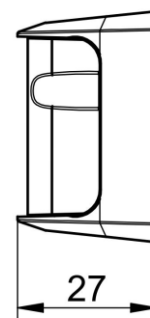

Product code EAN code	Photo	Description
0015-1051 5905591400756		clearance lamp LED, white, cable 0,5m
0015-1052 5905591400732		side-marker lamp LED, yellow, cable 0,5m
0015-1053 5905591400749		clearance lamp LED, red, cable 0,5m

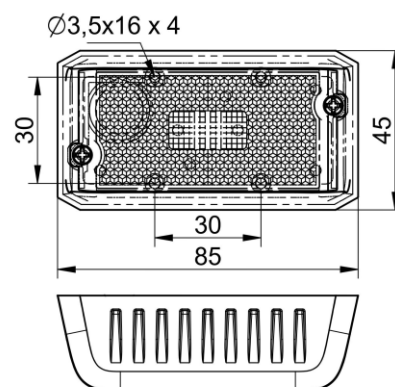

Clearance lamp with long bracket

DPT15 LED



INFO:

- designed to indicate the size of trailers (front, side, rear)
- can be installed with the bracket or directly on board the trailer
- compatible with various types of brackets
- electromagnetic compatibility (EMC)
- light source – LED
- homologation E20

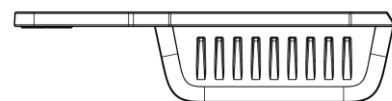
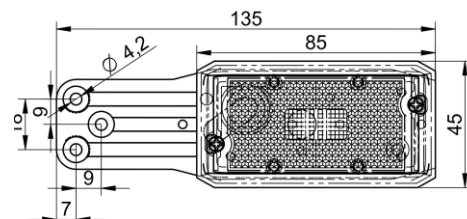
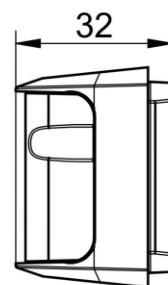

Product code EAN code	Photo	Description
0015-1051-02 5905591400626		clearance lamp LED, white, long bracket, cable 0,5m
0015-1052-02 5905591400657		side-marker lamp LED, yellow, long bracket, cable 0,5m
0015-1053-02 5905591400664		clearance lamp LED, red, long bracket, cable 0,5m

Clearance lamp with bracket

DPT15 LED



INFO:

- designed to indicate the size of trailers (front, side, rear)
- can be installed with the bracket or directly on board the trailer
- compatible with various types of brackets
- electromagnetic compatibility (EMC)
- light source – LED
- homologation E20

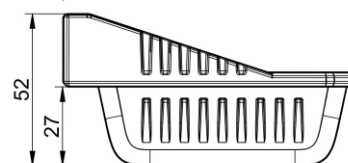
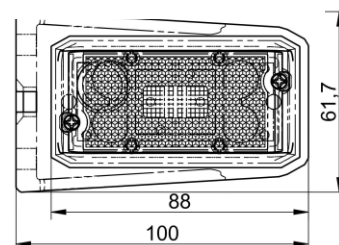
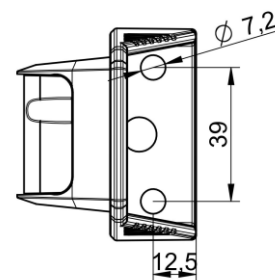

Product code EAN code	Photo	Description
0015-1051-01 5905591400565		clearance lamp LED, white, bracket, cable 0,5m
0015-1052-01 5905591400589		side-marker lamp LED, yellow, bracket, cable 0,5m
0015-1053-01 5905591400572		clearance lamp LED, red, bracket, cable 0,5m

NUMBER PLATE LIGHTS



Number plate light

DPT20 LED



INFO:

- modern design
- supply voltage 12/24V
- various mounting options
- electromagnetic compatibility (EMC)
- light source – LED module
- homologation E20

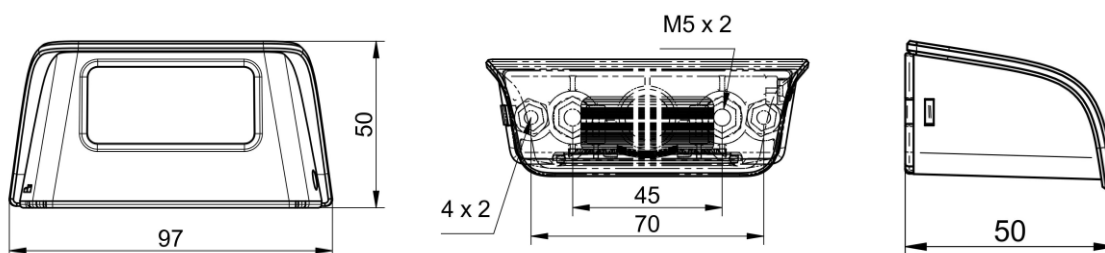

Product code EAN code	Photo	Description
0020-1051 5905591400770		rear registration plate light LED, cable 0,5m

Number plate light

DPT20



INFO:

- modern design
- supply voltage 12/24V
- various mounting options
- light source – bulb
- homologation E20

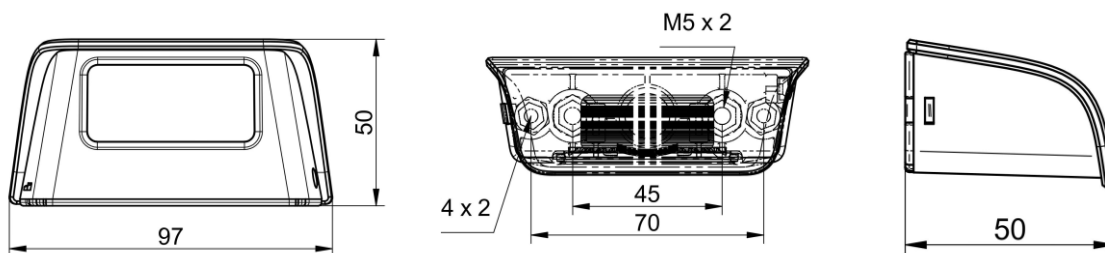

Product code EAN code	Photo	Description
0020-0001 5905591400787		rear registration plate light, grommet
0020-0051 5905591400763		rear registration plate light, grommet, cable 0,5m

REFLECTORS



Rectangular reflective devices

904011

5905591400060

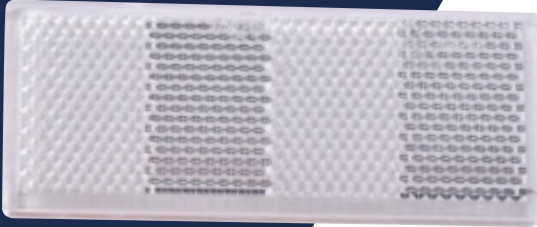

904001

5905591400114

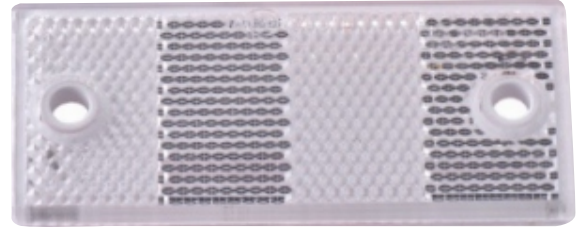

904012

5905591400077



904002

5905591400107



904013

5905591400084



904003

5905591400091



- reflective device 90x40mm with self-adhesive tape
- homologation E20
- class IA

- reflective device 90x40mm with holes
- homologation E20
- class IA

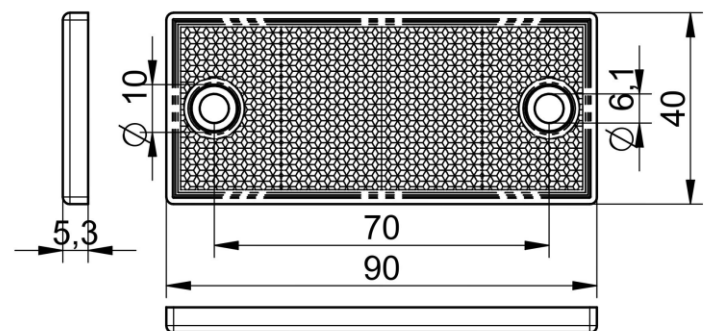
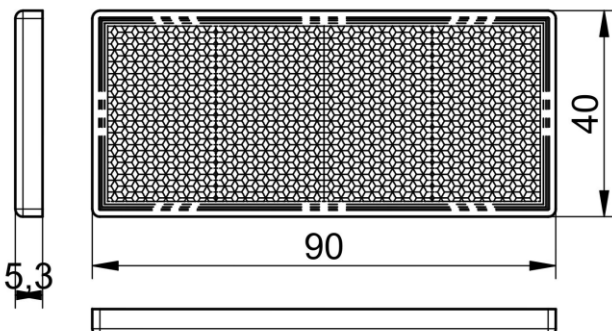

Rectangular reflective devices

763411
5905591400169



763412
5905591400152



763413
5905591400176

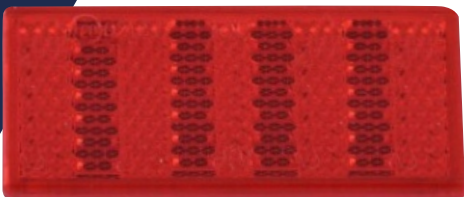

763401
5905591400121



763402
5905591400138



763403
5905591400145



- reflective device
76x34mm with
self-adhesive tape
- homologation E20
- class IA

- reflective device
76x34mm with holes
- homologation E20
- class IA

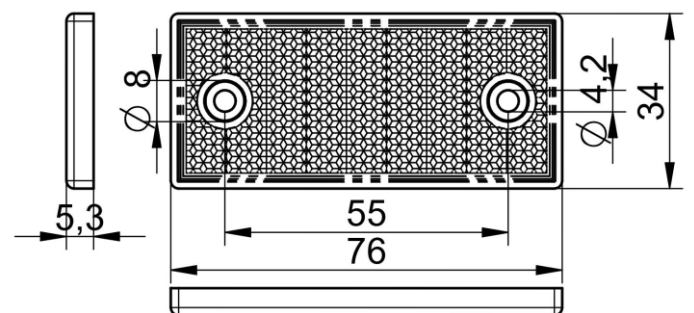
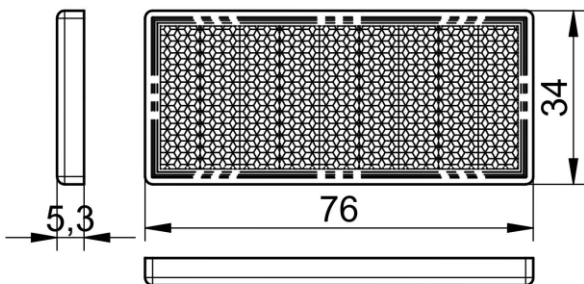

Rectangular reflective devices

1257001
5905591400190

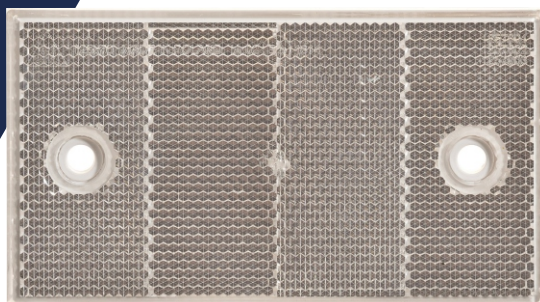

1257002
5905591400183

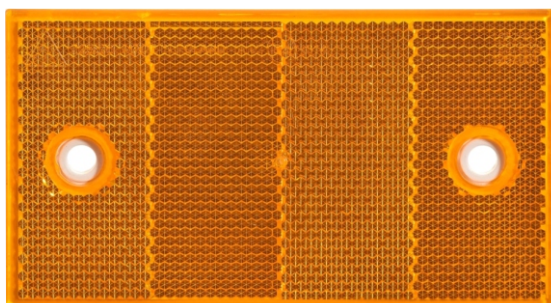

1257003
5905591400206

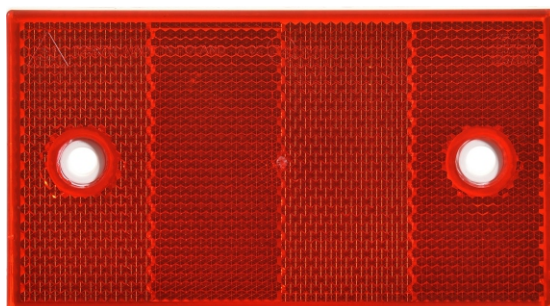

- reflective device
125x70mm with holes
- homologation E20
- class IA

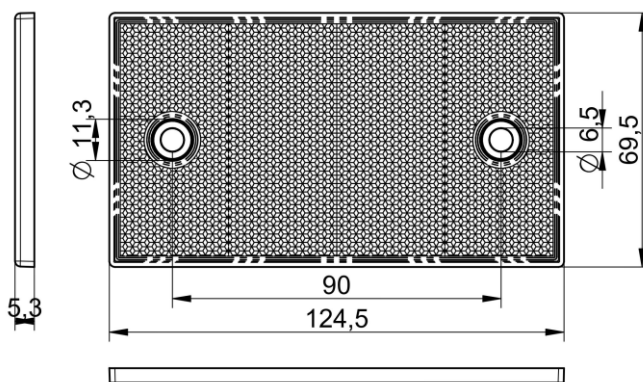

Round reflective devices

6011
5905591400299



6001
5905591400251



7601
5905591400220



6012
5905591400282



6002
5905591400244



7602
5905591400237



6013
5905591400275



6003
5905591400268



7603
5905591400213



- reflective device
Ø60 with a self-adhesive tape
- homologation E20
- class IA

- reflective device
Ø60 with a center hole
- homologation E20
- class IA

- reflective device
Ø76 with a center hole
- homologation E20
- class IA

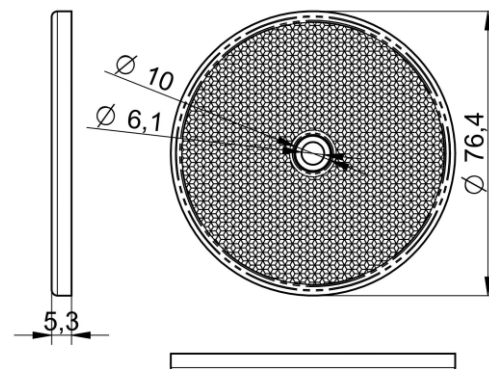
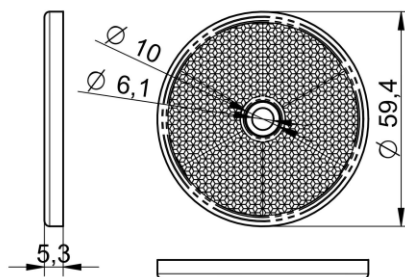
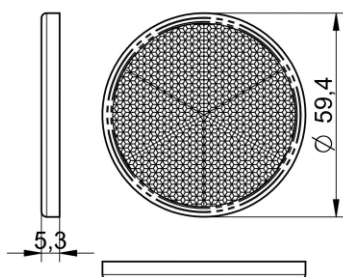



DOBPLAST

Triangular reflective devices

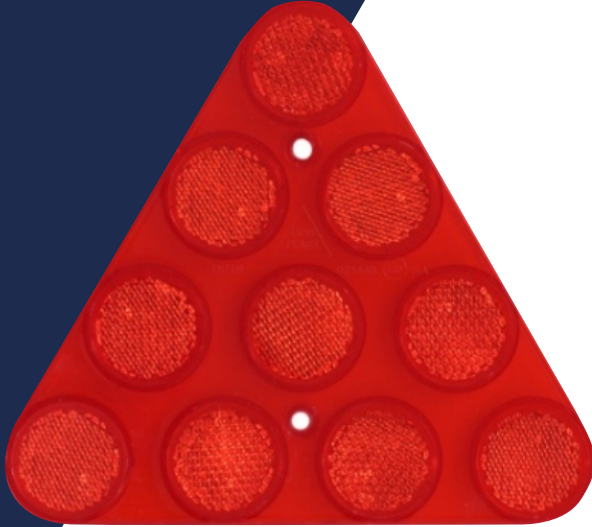

0009
5905591400305

- reflective device with bolts
- homologation E20
- class IA

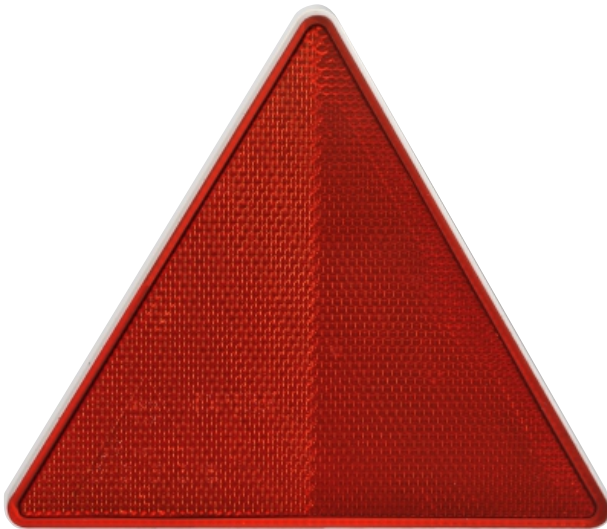
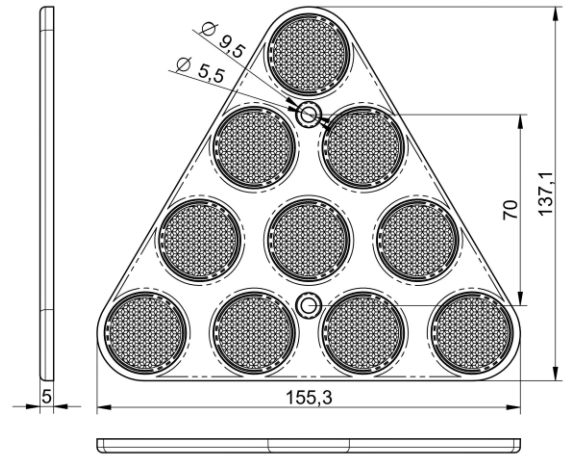

0035-0000
5905591400312

- reflective device with bolts
- homologation E20
- class IA

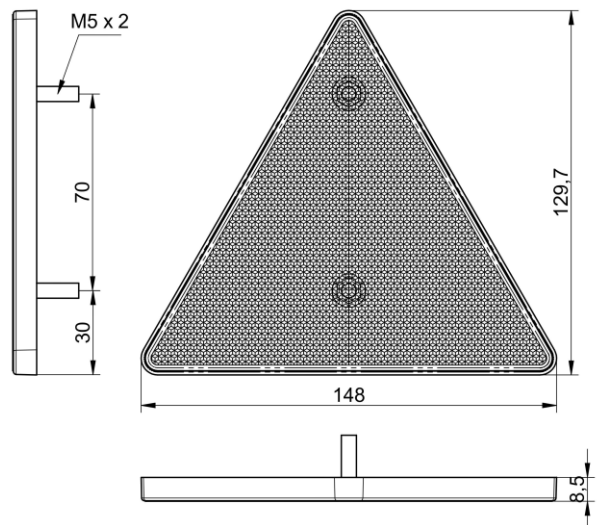

ACCESSORIES





Trailer wiring loom harness



5 PIN bayonet plug

5905591400343 - yellow
5905591400336 -green



Rope cleat for trailers

5905591400329

